

Alphacool Core 200 Aurora Reservoir Acetal/Acryl with VPP Apex Pump

Alphacool article number: 15381



Quick Info

The Alphacool Core reservoir has an integrated pump top for powerful D5 pumps and comes with a VPP Apex pump. The tube of the reservoir is made of acrylic, the D5/VPP pump top and the lid of acetal. The combination of these two materials gives the expansion tank a discreet appearance. The wow effect is provided by 12 digitally addressable RGB LEDs in the pump top and the Lighttower water effect inside the acrylic tube.

- Simple maintenance and control of the water cooling system
- Easy filling, draining and venting possible
- Brilliant digital aRGB illumination

Scope of delivery

1x Core 200 Aurora reservoir D5/VPP Acetal/Acryl, black	2x stand bracket
1x VPP Apex pump, black	1x screw plug
4x M4x6 screws	1x Allen key
8x M4x8 screws	1x Plug tool
8x M4x12 screws	1x Digital-RGB adapter
4x M3x5 screws	1x O-Ring 53x3,5 pump
4x M4 nuts	1x pump mounting
2x 120mm bracket	1x 140mm Rise pipe
2x 120 - 140mm bracket	

Technical data

L x W x H	251 x 76,5 x 76,5 mm
Pump compatibility	D5
Capacity	400 ml
Material Pump top & cover	acetal
Material tube	acrylic
Connection	3x G1/4" internal thread
Maximum working temperature	60 °C
Pressure tested	0,8 Bar
Quantity of digital aRGB LEDs	12
Power digital aRGB LEDs	5V
Power connector digital aRGB LEDs	3-pin JST (male & female switch)
Weight	621 g
Color	black

Technical data VPP Apex

Dimensions (L x W x H)	65 x 65 x 41mm
Material pump	synthetic material
Material pump cover	aluminium
Material axle	ceramics
Connections	4-Pin PWM SATA
Rotational speed	2500 - 4500 RPM
Cable lengths	4-Pin PWM - 48cm SATA - 48cm
Operating voltage	8-13V DC / 14W IP32
Starting voltage	12V DC
Maximum pumping head	4,25 m
Max flow	340 l/h
Max working temperature	60 °C
Net weight	276 g
color	black

Download links

Manual	15381_Alphacool_Core_200_Aurora_Reservoir_Acetal-Acryl_with_VPP_Apex_Pump_Manual.pdf
Product pictures	15381_Alphacool_Core_200_Aurora_Reservoir_Acetal-Acryl_with_VPP_Apex_Pump_pics.zip

Packaging dimensions per unit

L x W x H	350 x 150 x 110 mm
Weight	1360 g

Other data

Certificates	CE, FC, ROHS
EAN	4250197153812
Customs code	84733080000

The Alphacool Core reservoir has an integrated pump top for powerful D5 pumps and comes with a VPP Apex pump. The tube of the reservoir is made of acrylic, the D5/VPP pump top and the lid of acetal. The combination of these two materials gives the expansion tank a discreet appearance. The wow effect is provided by 12 digitally addressable RGB LEDs in the pump top and the Lighttower water effect inside the acrylic tube.

What's new?

Compared to the previous Eisbecher models, the acrylic tube of the Core reservoir has an external thread. This provides more stability and safety when connecting the lid and pump top to the tube. Also new is the integrated digital aRGB lighting. 12 digitally addressable RGB LEDs in the pump top are included in the scope of delivery of the Core reservoir and no longer have to be purchased separately.

Extensive mounting options

Mounting option 1:

Stands are included in the scope of delivery, which, among other things, allow the expansion tank to be mounted on the bottom of the enclosure.

Mounting option 2:

Included in the scope of delivery are 120mm/140mm mounting frames, which can be used to mount the Core expansion tank as desired on free fan spaces, radiators or on the fans on radiators.

Digitally addressable RGB lighting

12 digitally addressable RGB LEDs illuminate the acrylic tube of the reservoir. They are mounted in a ring at the lower end of the tube in the transition to the pump top and provide brilliant illumination of the entire expansion tank. In combination with the Lighttower water effect, a very special ambience is achieved. The digital aRGB LED lighting is connected via a JST 3-pin connector and can be controlled with a digital RGB controller (e.g. Alphacool Aurora Eiscontrol, Art.15360) or a digital RGB capable mainboard.

Lighttower water effect

A special water effect is created in the core reservoir via the riser tubes. If you do not fill the reservoir beyond the top edge of the riser tube, you get a kind of fountain effect. In this case, the water is pushed out the sides of the riser tube and splashed against the glass tube. Depending on the flow of the circuit, the effect is stronger or weaker. The effect can be placed at the lower or upper inlet using the riser tubes included in the delivery.

Pump compatibility

The Alphacool Core expansion tank has an integrated pump top and is compatible with all original D5 pumps as well as all Alphacool VPP pumps. The pump retaining ring, a pump O-ring and all screws are included in the scope of delivery.

Pump

The VPP Apex pump does without a spherical bearing and uses a ceramic shaft. The motor's coils have been moved from the inside to the outside. These changes have the effect that the pump is fundamentally more stable and smoother running, and any vibrations that arise have been significantly reduced. Another positive side effect is that power consumption has been almost halved as a result. Compared to Alphacool's Eispumpe, the power is not supplied via a 4-pin Molex connector. Instead, the Apex VPP pump is connected to the power supply using a SATA connector. The Apex VPP pump has a 4-pin fan connector that connects to the motherboard or to an external controller. This allows you to control the speed range of the pump via PWM and read out the RPM signal.

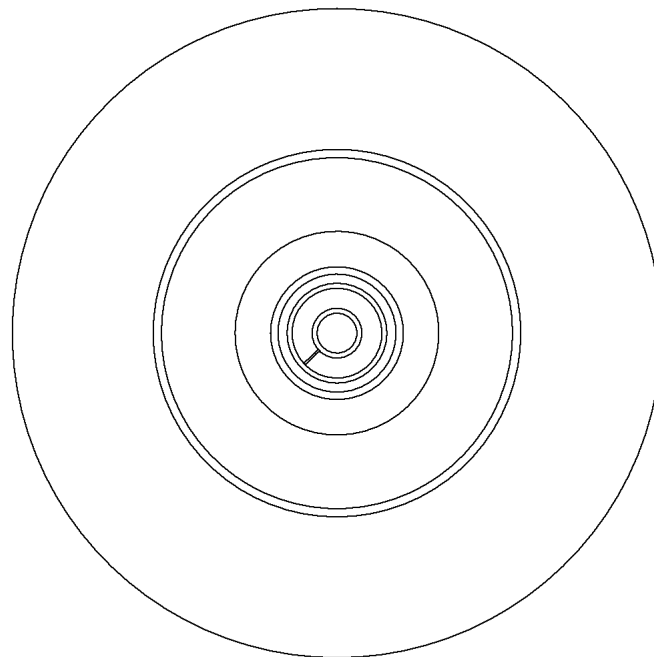
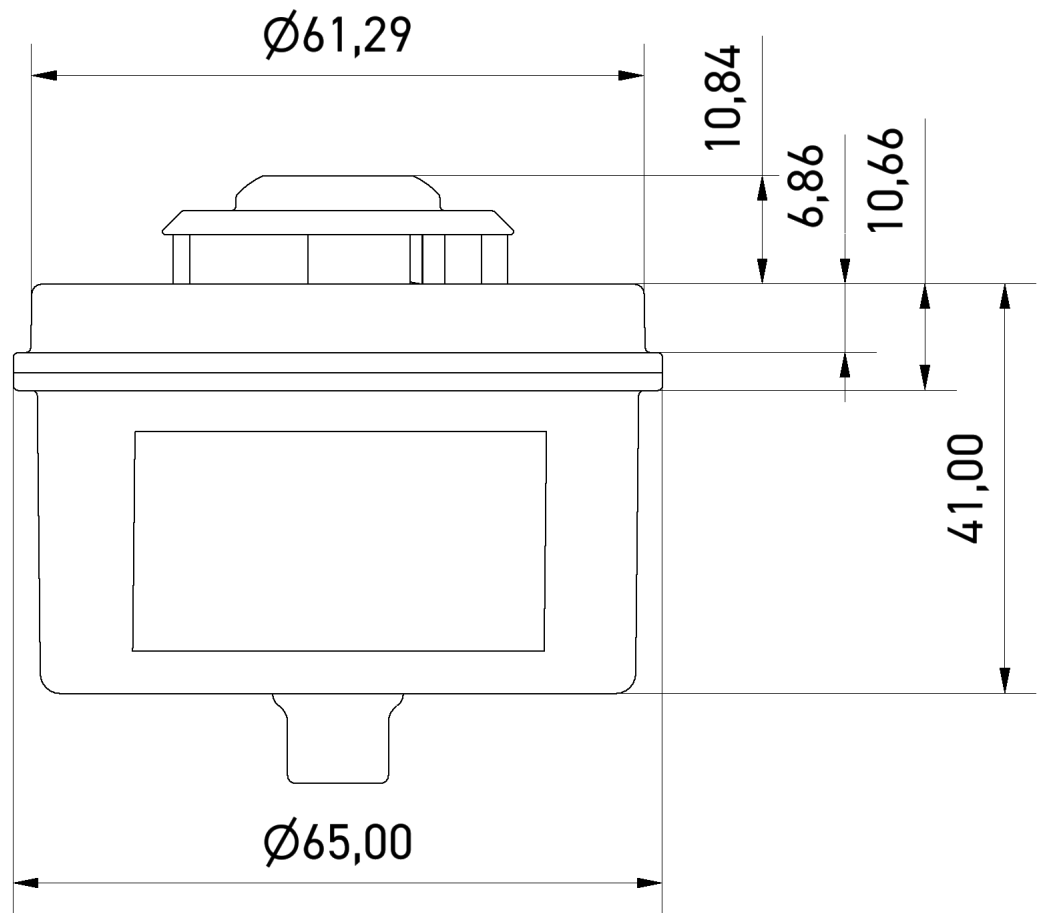

Drawing (2)

